

Application Note

Utilizing the TSS-23ULN+ MMIC LNA from 700 to 800 MHz

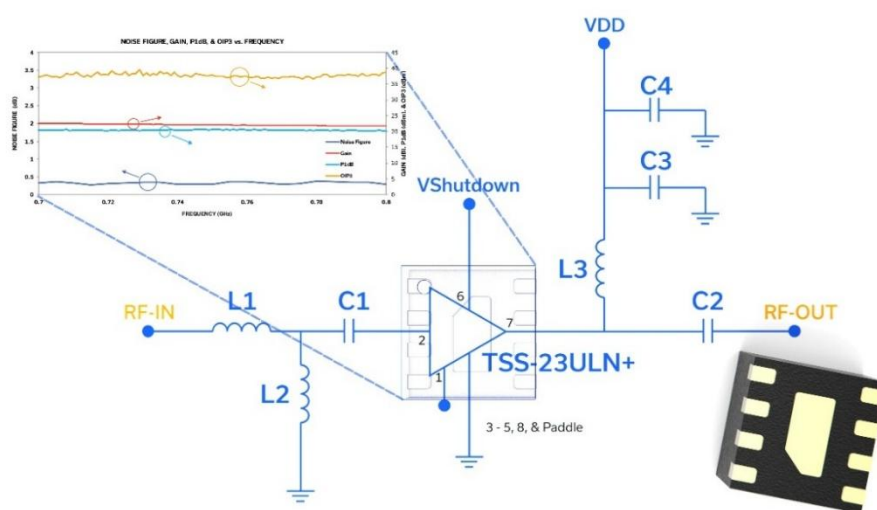

Introduction

A low-noise amplifier (LNA) is a critical component typically found in any receiver chain. Its purpose is to amplify an extremely weak signal captured by the receiver's antenna while adding minimal noise power to the signal. Today, Mini-Circuits offers a vast assortment of LNAs that customers can choose from, including both MMIC LNAs and connectorized versions.

One recently released model from Mini-Circuits is the [TSS-23ULN+](#) ultra-low-noise MMIC LNA (Fig. 1). Based on pseudomorphic-high-electron-mobility-transistor (pHEMT) technology, the TSS-23ULN+ is specified for an operating frequency range of 10 MHz to 2 GHz and is equipped with a voltage-controlled shutdown feature. The device operates from a single +5 V DC supply, with typical current consumption of 71 mA. One notable aspect of the TSS-23ULN+ MMIC LNA is its size, as it comes in a small 2 × 2 mm, 8-lead QFN-style package. Finally, the TSS-23ULN+ is intended for a wide range of applications, including cellular infrastructure, satellite communications (satcom), radar, and others.



Figure 1. TSS-23ULN+ MMIC LNA.

In this application note, we show how the TSS-23ULN+ can be used to design an LNA with an operating frequency range of 700 to 800 MHz. An application circuit is demonstrated that provides a clear understanding of how to use the device. Measured data is provided that illustrates the level of performance that can be achieved.

Functional Aspects of the TSS-23ULN+ MMIC LNA

Figure 2 shows the functional diagram for the TSS-23ULN+. Pin 2 is used to connect the RF input signal to the device, while Pin 7 is used to connect both the RF output signal and the DC supply voltage (V_{DD}). While the typical value of V_{DD} is specified as +5 V, V_{DD} can range from +2.7 to +5.25 V. Furthermore, Pin 6 is the shutdown voltage ($V_{SHUTDOWN}$) pin. Applying 0 V to this pin sets the TSS-23ULN+ to the ON state. The ON state is still in effect when the voltage applied is as high as +1.3 V. To set the TSS-23ULN+ to the OFF state, a minimum voltage of +1.4 V must be applied to the $V_{SHUTDOWN}$ pin. For the OFF state, the datasheet specifies a typical condition as $V_{SHUTDOWN} = V_{DD}$ (i.e., $V_{SHUTDOWN} = +5$ V when $V_{DD} = +5$ V, $V_{SHUTDOWN} = +3$ V when $V_{DD} = +3$ V, etc.).

FUNCTIONAL DIAGRAM

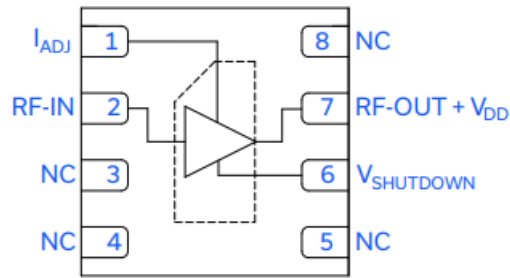

Figure 2. Functional diagram of the TSS-23ULN+ MMIC LNA.

Pin 1 is used for current adjustment. For nominal operation, this pin must be left floating. Pins 3, 4, 5, and 8 are not used internally. They can either be connected to ground or left floating. Finally, as is the case for a QFN-style package, the TSS-23ULN+ has an exposed pad (i.e., paddle) that must be connected to ground.

LNA Application Circuit

To fully demonstrate the LNA application circuit featuring the TSS-23ULN+ MMIC LNA, we narrow down its specified operating frequency range of 10 MHz to 2 GHz to the targeted frequency range of 700 to 800 MHz. While the TSS-23ULN+ can be considered a wideband device, the goal of this circuit design is to optimize the performance over the specific frequency band of 700 to 800 MHz. This frequency range covers various 5G NR frequency bands, including the 5G NR n12, n13, and n14 bands.

Figure 3 shows the schematic of the application circuit that includes the TSS-23ULN+ device. Here, V_{DD} will be set to +5 V, while $V_{SHUTDOWN}$ will be set to 0 V. Included in the schematic are the appropriate capacitors and inductors for matching and DC biasing. L1, L2, and C1 represent the input matching network. L3 serves as an RF choke, while C2 serves as a DC blocking capacitor. L3 and C2 also represent the output matching network. Finally, C3 and C4 serve as RF bypass capacitors.

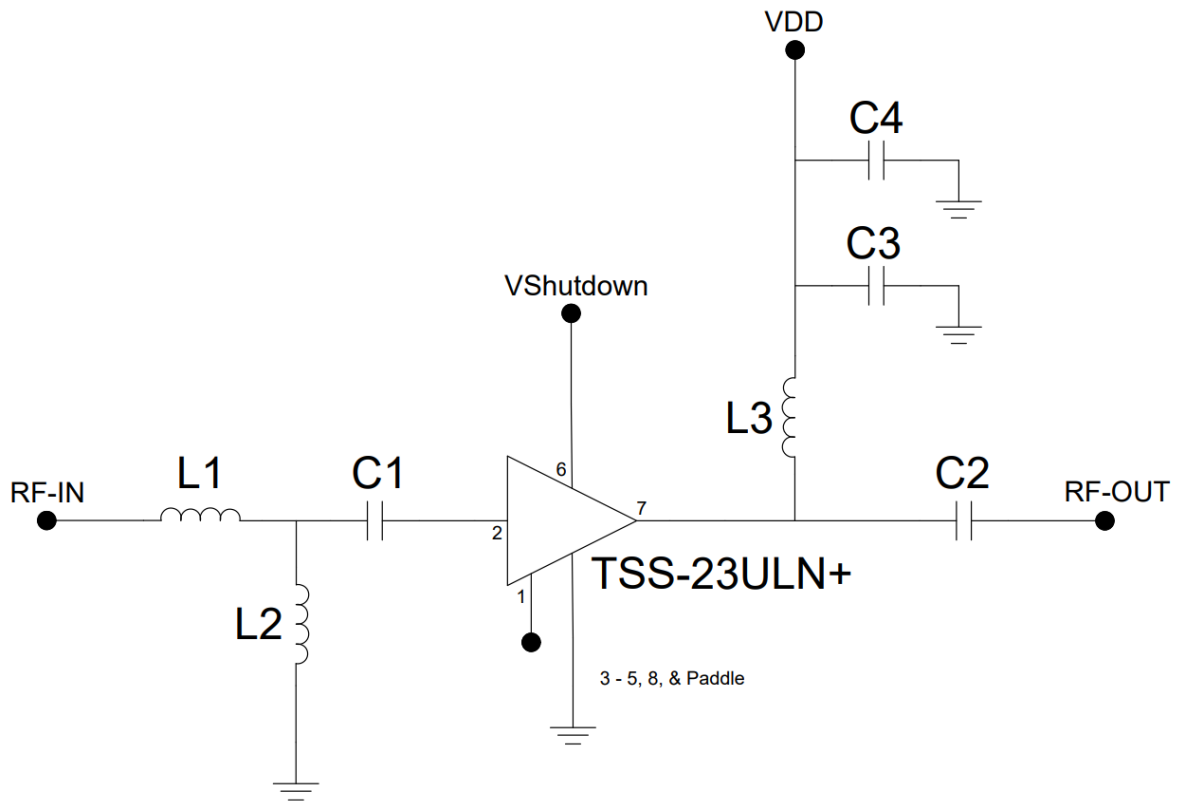

Figure 3. Schematic of the 700 – 800 MHz application circuit that includes the TSS-23ULN+ device.

Figure 4 shows an assembled test board. Note that the substrate is 10 mil Rogers 4350B. In this case, pins 3, 4, 5, 8, and the paddle are connected to ground, while pin 1 is left floating. Finally, Table 1 lists all the parts used for this circuit.

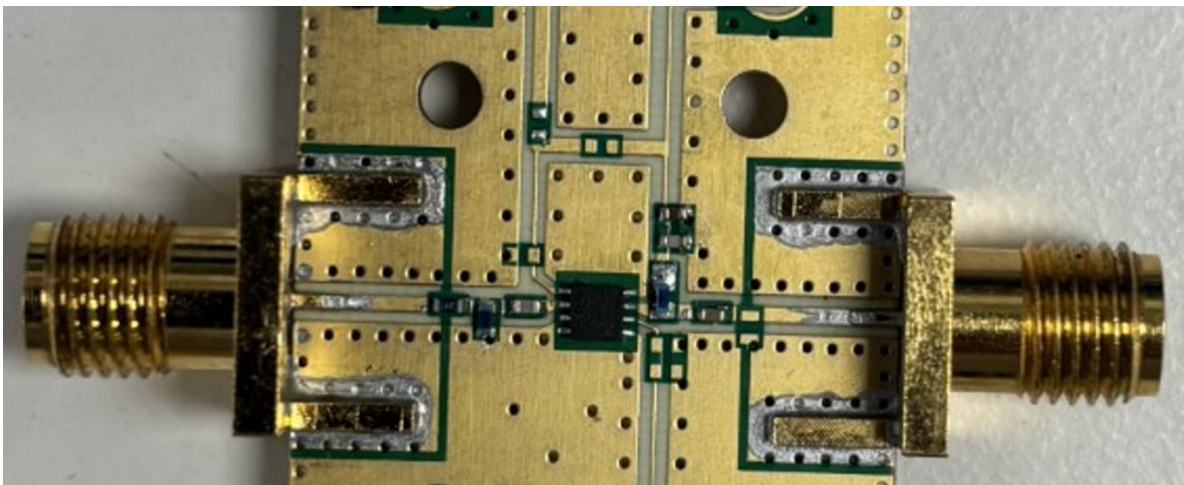

Figure 4. Fully assembled 700 – 800 MHz test board.

Table 1: Parts list of the LNA circuit.

Component	Value	Manufacturer	Part Number
C1	12 pF	Passive Plus	0402N120JW201
C2	30 pF	Passive Plus	0402N300JW500
C3	100 pF	KEMET	CBR04C101JAGAC
C4	0.1 μ F	KEMET	C0402C104M4PACTU
L1	4.7 nH	Coilcraft	0402DC-4N7XGRW
L2	120 nH	Coilcraft	0402DC-R12XGRW
L3	68 nH	Coilcraft	0402DC-68NXGRW
Amp		Mini-Circuits	TSS-23ULN+

Optimized Performance: Gain, Isolation, Return Loss, and Noise Figure

We can now see how well the circuit performance has been optimized by looking at measured data of the test board. All measurements were performed using a vector network analyzer (VNA). These measurements include gain, isolation, input/output return loss, and noise figure. In addition, to demonstrate the nonlinear performance, output power at 1-dB compression (P1dB), output third-order intercept point (OIP3), and output second-order intercept point (OIP2) were measured. Note that all measurements correspond to the complete test board with the RF connectors (i.e., no elements are de-embedded from the measured data).

Figure 5 shows the measured gain, isolation, input return loss, and output return loss. The gain ranges from 22.6 dB at 700 MHz to 21.7 dB at 800 MHz. The isolation is greater than 27 dB across the targeted frequency range of 700 to 800 MHz. For the input and output return loss, the circuit achieves values greater than 15 and 13 dB, respectively, over the intended frequency range. Figure 6 shows the results of the same measurements when performed over a wide frequency range of 10 MHz to 10 GHz. Moreover, Figure 7 shows the stability factor (K) along with the stability measure (B). The results show that the circuit achieves unconditional stability.

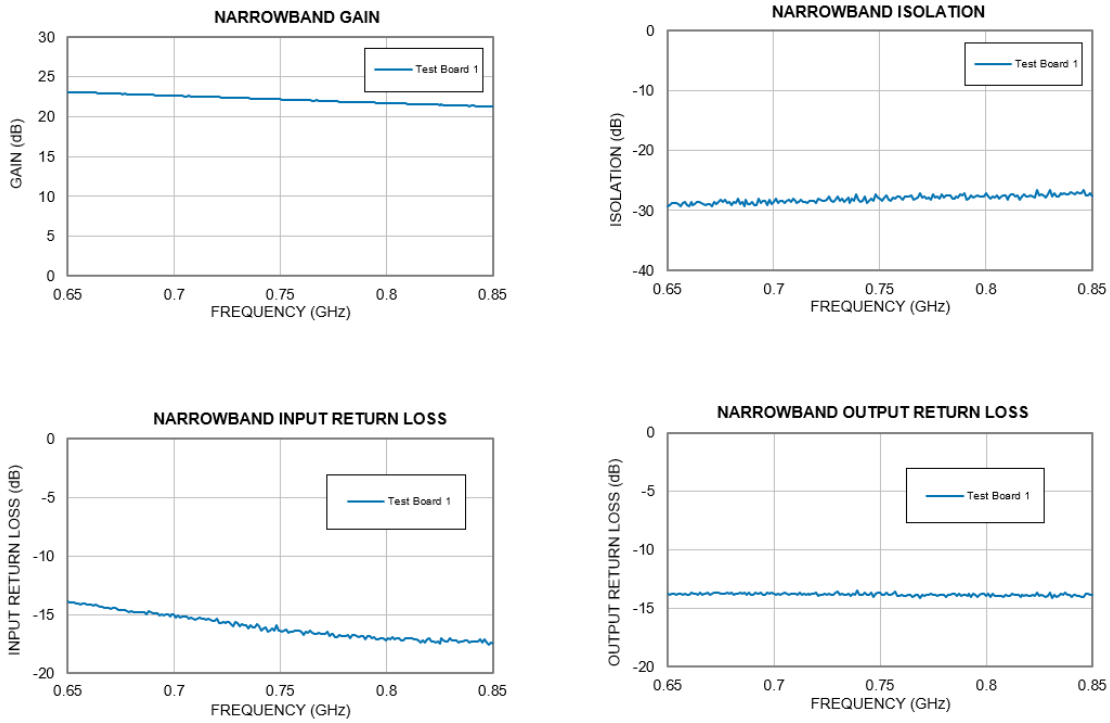

Figure 5. Measured gain (top left), isolation (top right), input return loss (bottom left), and output return loss (bottom right).

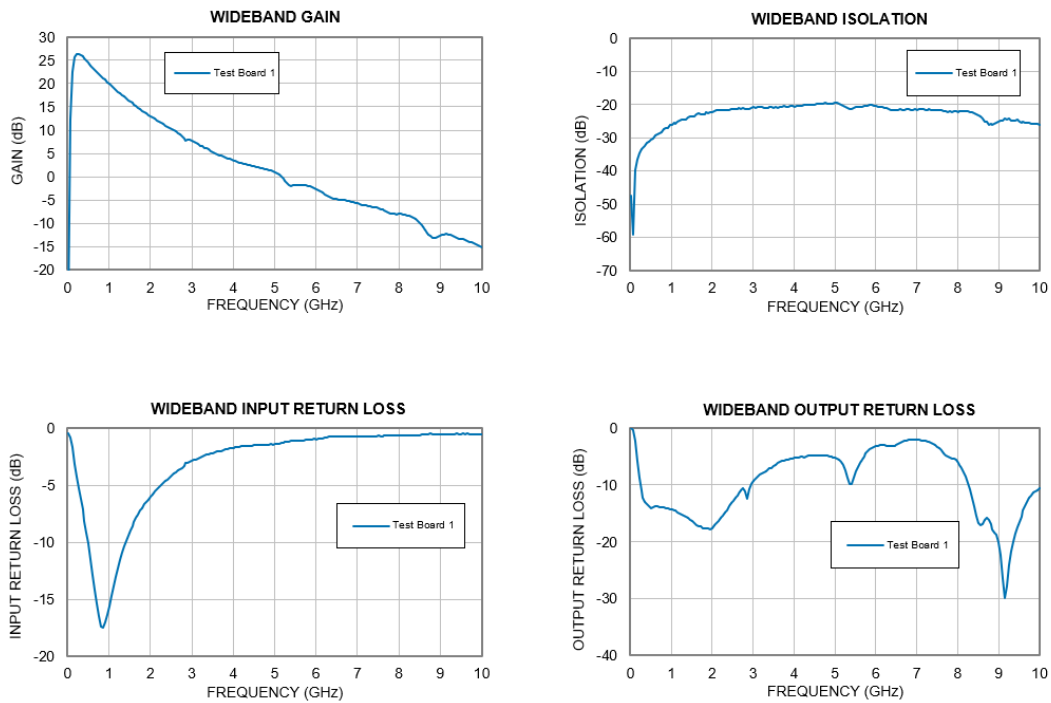

Figure 6. Wideband measured gain (top left), isolation (top right), input return loss (bottom left), and output return loss (bottom right).

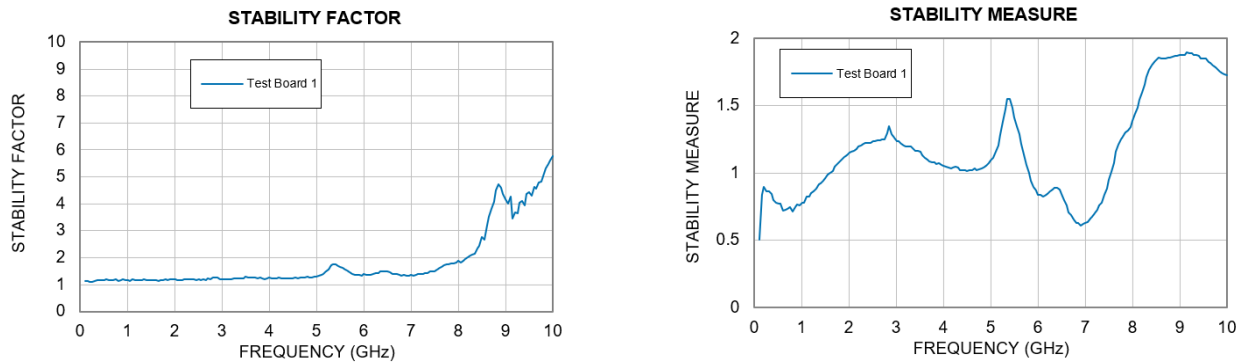

Figure 7. Measured stability factor (K) and stability measure (B).

Of course, noise figure is a critical parameter for any LNA. Figure 8 shows the measured noise figure of the complete LNA circuit. We see that the noise figure does not exceed 0.4 dB across the targeted frequency range of 700 to 800 MHz.

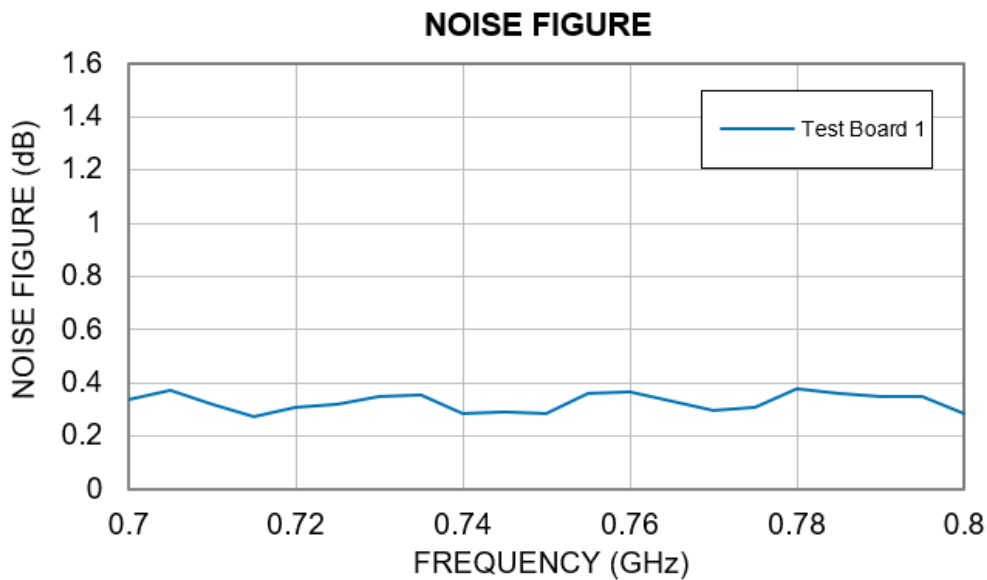

Figure 8. Measured noise figure.

Nonlinear Performance

In addition to achieving high gain and low noise figure as shown previously, the TSS-23ULN+ MMIC LNA achieves high P1dB and OIP3 levels as well. To demonstrate, Figure 9

shows the measured P1dB. The results show that the P1dB is greater than +20 dBm across the frequency range of 700 to 800 MHz. These results are impressive for a device biased with just +5 V at 71 mA.

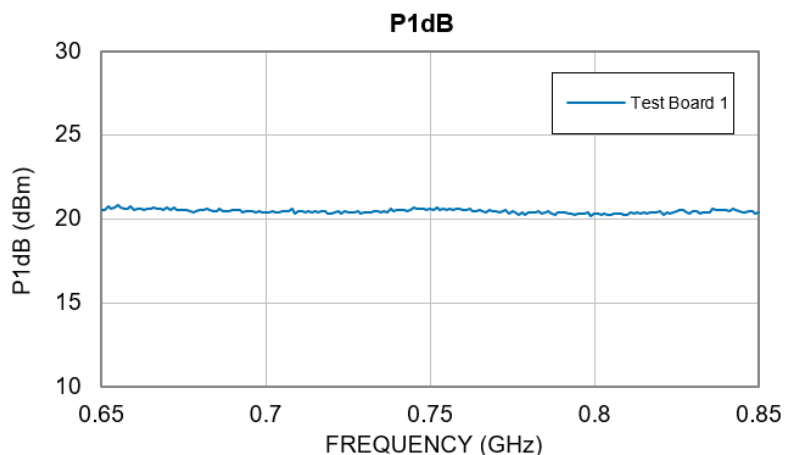

Figure 9. Measured P1dB.

Figure 10 shows the measured OIP3 across the targeted frequency range, with the level of each of the output fundamental tones set to a fixed value of +4 dBm for all frequencies. Note that the fundamental tones are spaced 1 MHz apart. The results show the OIP3 is greater than +36 dBm over the intended frequency range. Figure 10 also shows the measured OIP3 for output fundamental tone levels ranging from +4 to +14 dBm. The results are shown for three frequencies: 700, 750, and 800 MHz. Again, the fundamental tones are spaced 1 MHz apart.

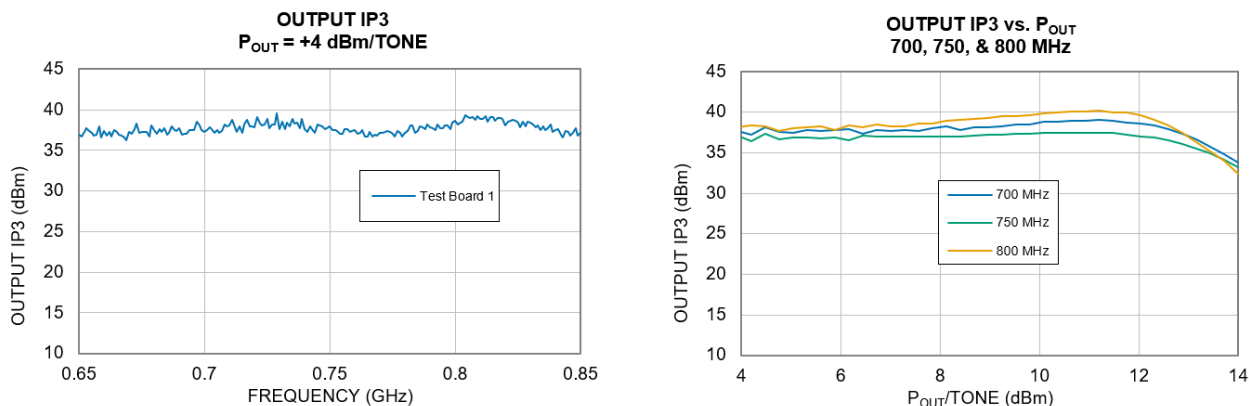

Figure 10. Shown on the left is the measured OIP3 versus frequency, with the fundamental tone set to a fixed value of +4 dBm. Shown on the right is the measured OIP3 versus fundamental tone levels for three frequencies.

In certain cases, OIP2 may also be an important parameter. Figure 11 shows the measured OIP2 across the targeted frequency range. Again, the level of each of the output fundamental tones is set to a fixed value of +4 dBm. Figure 11 also shows the measured OIP2 for output fundamental tone levels ranging from 0 to +14 dBm. The results are once again shown for 700, 750, and 800 MHz. Note that the fundamental tones are still spaced 1 MHz apart. Also note that the results shown correspond to the second-order sum term ($f_1 + f_2$).

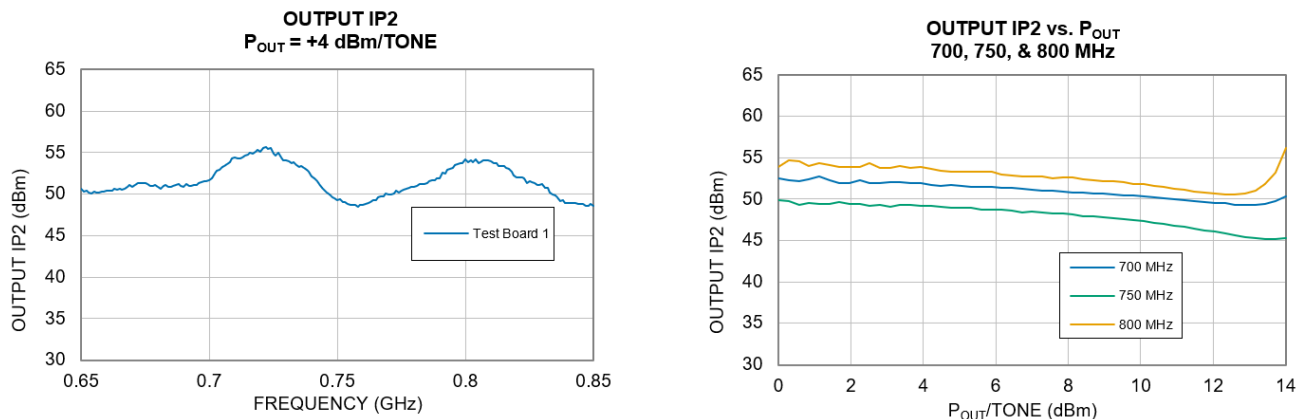

Figure 11. Shown on the left is the measured OIP2 versus frequency, with the fundamental tone set to a fixed value of +4 dBm. Shown on the right is the measured OIP2 versus fundamental tone levels for three frequencies.

Conclusion

In this application note, we demonstrated how the Mini-Circuits TSS-23ULN+ MMIC LNA performs when used to build an LNA circuit that is optimized for use from 700 to 800 MHz. Over this frequency range, the LNA circuit achieves high gain (21.7 dB minimum), very low noise figure (0.4 dB), high P1dB (+20 dBm), and high OIP3 (+36 dBm). All this performance is available from a device that operates from a single +5 V DC power supply, consumes only 71 mA, and comes in a small 2 × 2 mm QFN-style package that can be easily integrated into densely packed printed-circuit-board (PCB) layouts. On top of that, a voltage-controlled shutdown feature enables the TSS-23ULN+ to be quickly disabled for power conservation when not in use.

Contact

Mini-Circuits

13 Neptune Avenue

Brooklyn, NY 11235

Phone: +1-718-934-4500

Email: sales@minicircuits.com

Web: www.minicircuits.com

Important Notice

This document is owned by Mini-Circuits and is protected by copyright, trademark and other intellectual property laws.

The information herein is provided by Mini-Circuits as an accommodation to our customers and may be used only to promote and accompany the purchase of Mini-Circuits' parts. This guide may not be reproduced, modified, distributed, published, stored in an electronic database, or transmitted and the information contained herein may not be exploited in any form or by any means, without prior written permission from Mini-Circuits.

This guide is subject to change, qualifications, variations, adjustments or modifications without notice and may contain errors, omissions, inaccuracies, mistakes or deficiencies. Mini-Circuits assumes no responsibility for, and will have no liability on account of, any of the foregoing. Accordingly, this document should be used as a guideline only.

Trademarks

All trademarks cited within this guide are the property of their respective owners. Neither Mini-Circuits nor the Mini-Circuits products are affiliated with or endorsed or sponsored by the owners of the above referenced trademarks.

Mini-Circuits and the Mini-Circuits logo are registered trademarks of Scientific Components Corporation.